



Digital Display Solution 2025



What does the industry need for digital media today?

Organizational Challenges Faced Today

Lack of dedicated handling

Between Marcomm, Product/Brand, Content, and IT, who should take charge?

IT team is too busy and unable to address digital media tasks



STARTUP & SME company

To have comprehensive digital signage capabilities, yet they want to utilize standard home TVs.

Software solutions from China or Korea lack a clear roadmap, features, and local support.

Discover how our digital signage solutions can empower your business to achieve its goals.



Then, what is the suitable CMS (Content Management System) software?

Some software vendors are incomplete!



Software vendors and brands have no local support!

Several LCD brands have different software each!

Software from China, lacks roadmap / features, and local support



We Need this for our Digital Media in our company

- **Software that can manage hundreds of thousands of layers, various brands, and even videotrons.**
- **Look for a vendor that provides a complete solution, from sales to installation and managed services.**
- **The company requires options for purchase, rent, and even inquiring about managed services.**
- **A Digital Signage partner that can meet diverse, evolving, and dynamic business needs.**

InnoGRAPH offers various solution services as follows:

Various Business Models: in the form of sales services, rental of Digital Media Display, support, consultation, systems integration, specific/customer requirements, and even up to full managed services.



Media Display Services (MDS): monthly paid digital media display rental services, supported by Digisign Play CMS and various other services for periods of 12/24/36 months.

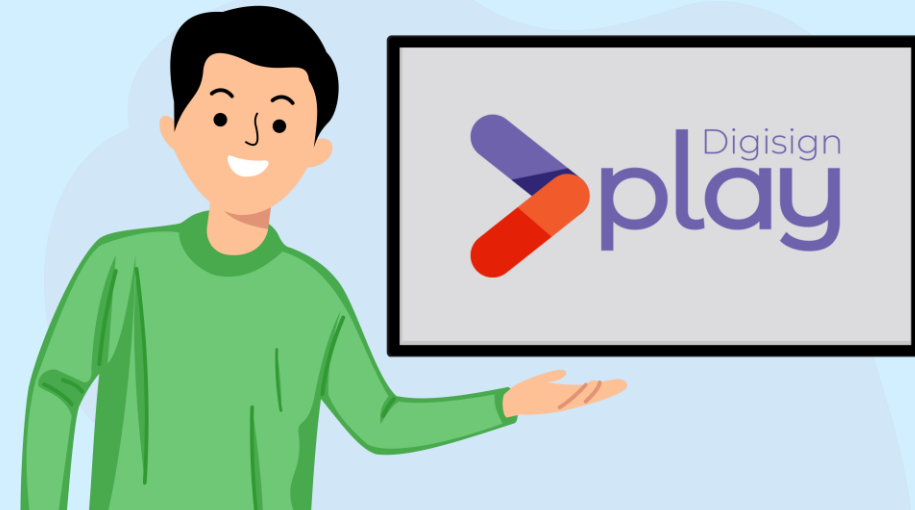

Digisign Play: CMS software for all types of Digital Media (LCD) from various brands, operating systems, including LED Videotrons, with complete capabilities supporting small, medium, and large customer-based LCD.

Various types of services and support



One contracts for all



installation services



content updates*



**comprehensive managed services
or outsourced operations in the
field of digital media.**

**And also,
explore other digital
media solutions (Kiosks,
Interactive Flat Panels,
Podiums, etc.)
from InnoGRAPH.**

**Display Options:
We provide LCD and
LED (Videotron)
digital display
options for various
usage needs,
with demos/samples
available for prototyping,
and part of our stock
ready for installation.**

What is Digisign play ?

Digisign play is a new cloud-based CMS solution used to easily manage content on your digital signage network through a web browser. Digisign play is a solution for various industries, such as F&B, hospitality, education, corporate, manufacturing, and more



Feature Digisign Play:

- Display Management-Device Management
- 3-methods publish content to player
- Default Layout
- Scheduling Layout
- Schedule Campaign
- Interface & Experience friendly user
- Simple-Touchscreen display supported
- Grouping for player and media display
- Control your own reports
- Choose your own schedule for content
- Screenshot display for checking latest content
- Proof of play for advertising (optional)
- Detail display device information

Digisign Play CMS implementation on digital display				
Feature	TV HDMI with USB	TV android / android box low cost	TV with android box	Professional display
Timer ON/Off	X	X	✓	✓
Screen Rotation	X	X	✓	✓
Content transition	X	✓	✓	✓
Auto start apps	X	✓	✓	✓
Remote desktop	X	✓	✓	✓
Device monitoring	X	✓	✓	✓



The digital display options from InnoGRAPH



**DIGISIGN LED
DIGITAL BANNER**
PAGE: 9



**DESKTOP DISPLAY
& WALLMOUNT**
PAGE: 13-14



**ANDROID TV
AS DIGITAL MEDIA**
PAGE: 18



**DIGISIGN LED DIGITAL
BANNER OUTDOOR**
PAGE: 10



**DIGISIGN DUAL SIDE
HANGING LCD**
PAGE: 15



**DIGITAL SIGNAGE PLAYER
DIGISIGN ANDROID BOX**
PAGE: 19

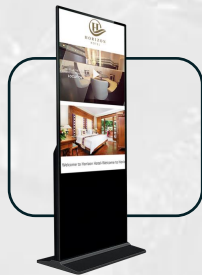

**DIGISIGN
SLIM FLOORSTAND
LITE V2**
PAGE: 11



DIGISIGN LIFT DISPLAY
PAGE: 16



**DIGISIGN DIGITAL
MENU BOOK**
PAGE: 20



DIGISIGN FLIP DISPLAY
PAGE: 21



**DIGISIGN FLOORSTAND
S SERIES**
PAGE: 12

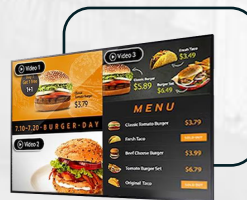

**PROFESSIONAL/
COMMERCIAL DISPLAY**
PAGE: 17



**QSTECH
LED VIDEOTRON INDOOR**
PAGE: 23



QSTECH LED VIDEOTRON INDOOR FOR RETAIL
PAGE: 24

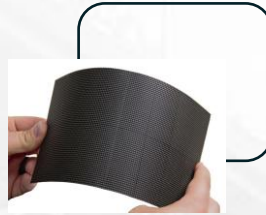

LED FLEXIBLE DISPLAY (SPECIAL SHAPE)
PAGE: 29



DIGISIGN DIGITAL TEACHING STATION
PAGE: 36



VIDEOTRON FOR MEETING ROOMS, CONFERENCES HALL, AUDITORIUM
PAGE: 25



LED DISPLAY CUSTOM SHAPE
PAGE: 30



DIGITAL PODIUM
PAGE: 37

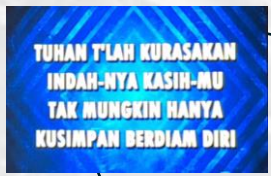

VIDEOTRON FOR PLACES OF WORSHIP
PAGE: 26



SHELF HEADER LED DISPLAY OUTDOOR
PAGE: 31



DIGISIGN RETAIL KIOSK
PAGE: 38



SPECIAL STRETCH LCD DISPLAY
PAGE: 32



VIDEOTRON FOR GENERAL USE
PAGE: 27

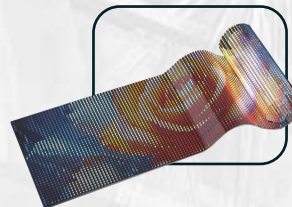

LED TRANSPARANT SERIES
PAGE: 33



DIGISIGN INTERACTIVE DISPLAY TABLE
PAGE: 39



LED VIDEOTRON OUTDOOR
PAGE: 28

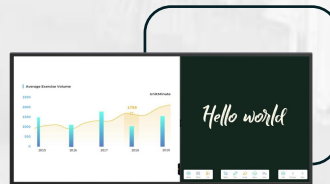

COMMAND CENTER / CONTROL ROOM DISPLAY
PAGE: 34



ICE BOARD X2 SERIES
PAGE: 40



Dimension:

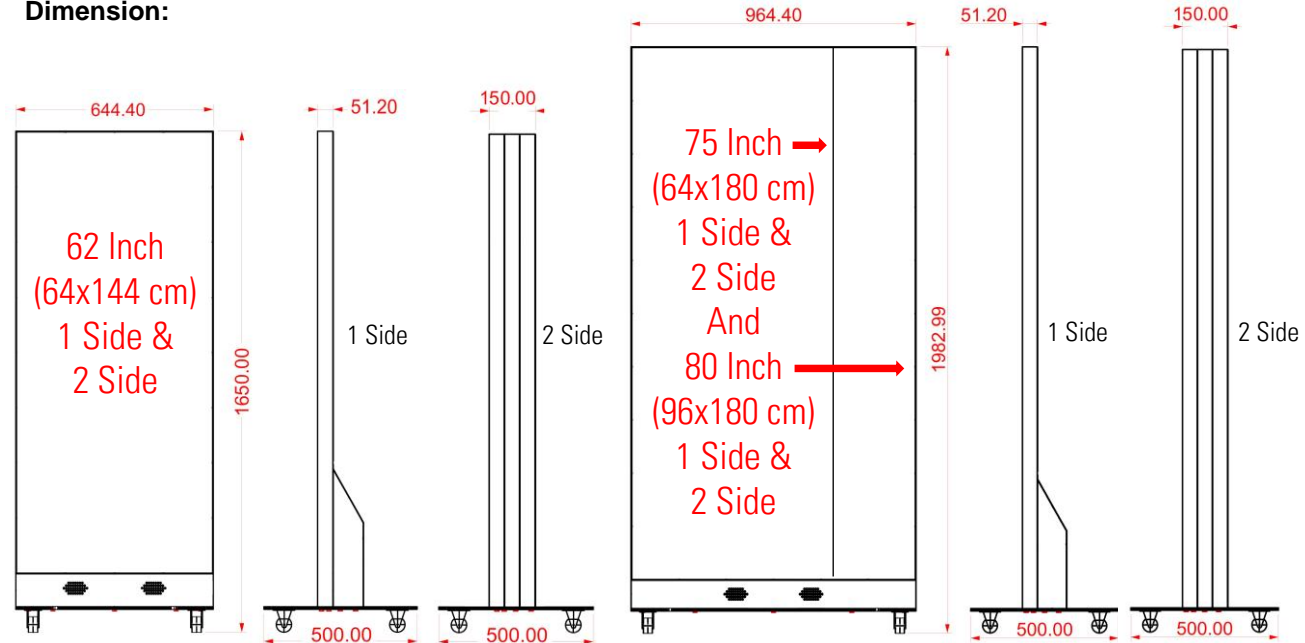

DigiSIGN LED digital banners designed like banners or posters with LED modules and frames capable of displaying promotions, information or highlight the event well.

- Available in 62", 75", 80" (1 and 2 side or custom)
- Choices of Pixel pitch P1.8 or P2.5
- Update content with digiSIGN Play, USB, Web or Internet
- Control via Smart Phone / Tablet.
- Full View
- Narrow bezel

Specification:

- Iron frame finished with powder coating
- Power Consumption 272 Watt Until 1020 Watt
- Controller : PCON 200 Pro (2K)

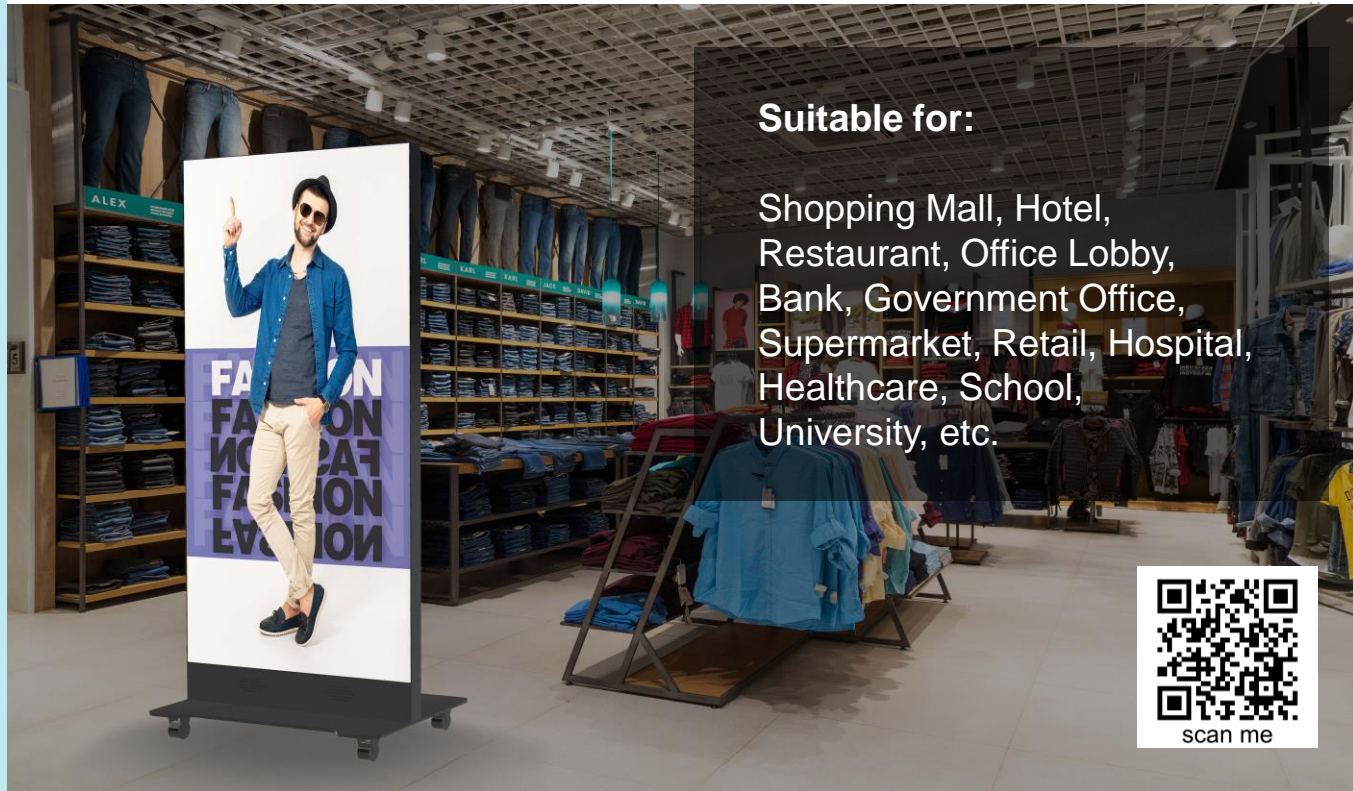

Suitable for:

Shopping Mall, Hotel, Restaurant, Office Lobby, Bank, Government Office, Supermarket, Retail, Hospital, Healthcare, School, University, etc.



scan me



DigiSIGN LED digital banners outdoor are specially designed and strong to be placed in extreme areas but still able to display your advertising.

Dimension:

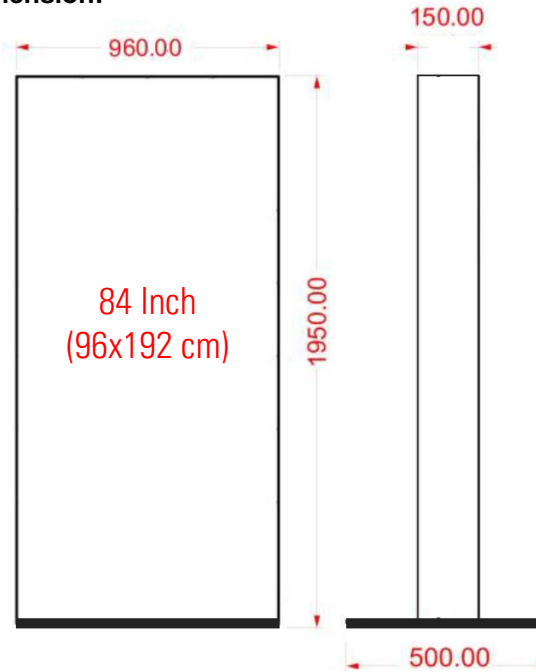

- Available 84 Inch
- Choices of Pixel pitch P4.0
- Update content with Digsign Play.
- Control via Smart Phone / Tablet.
- Full View & Narrow bezel.
- Controller : Novastar, Colorlight, Huidu



Suitable for:

Outdoor Shopping area, Outdoor Parking area, Office Lobby, Totem for Bank, Hospital, school area, Government Office outdoor, etc.



Suitable for:

Shopping Mall, Hotel, Restaurant, Office Lobby, Bank, Government Office, Supermarket, Retail, Hospital, Healthcare, School, University, etc.

Dimension:

DigiSIGN Slim Floorstand able to display promotions and event highlights information. A very contemporary and sleek appearance, high screen brightness makes various promotional materials and information even more attractive to visitors.

- Available Size 43 and 55 Inch in interactive touch and dynamic (non interactive)
- Super slim design
- Content can be easily changed update content with Digsign Play
- Cover with tempered glass
- Color black (Other Color or size on request)
- Wheel

Specification:

- Android 11 RK3568
- 350 Nits Brightness
- Network : WIFI, LAN
- 10 Points touch for interactive
- Resolution 1080 x 1920
- Lifetime 50000 Hours

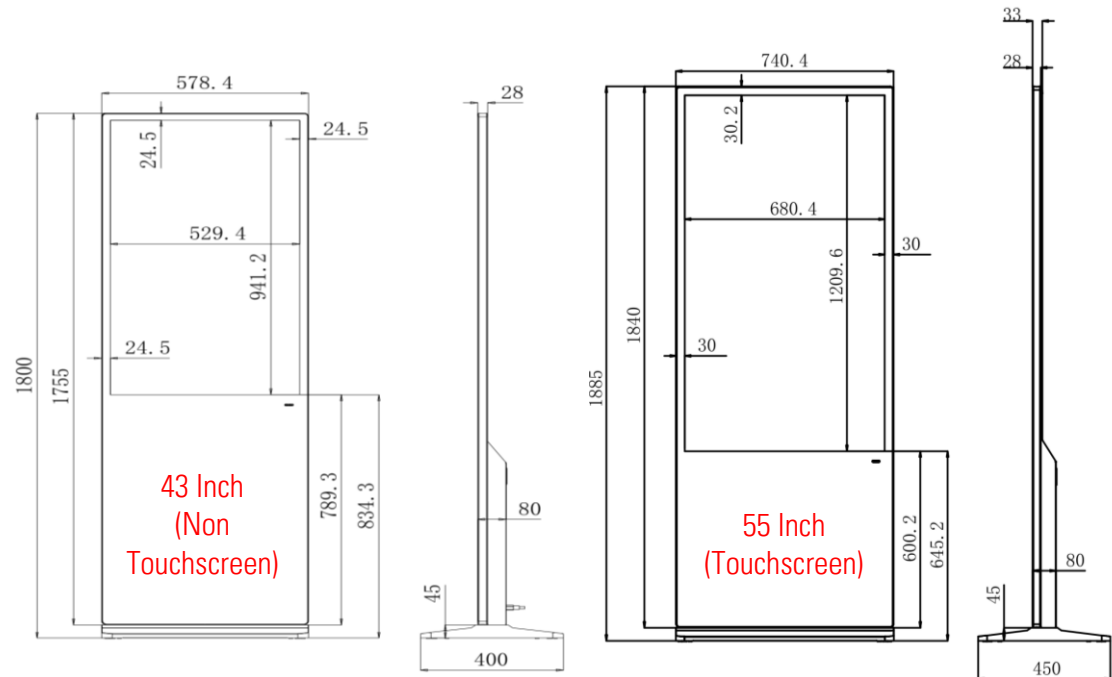



Dimension:

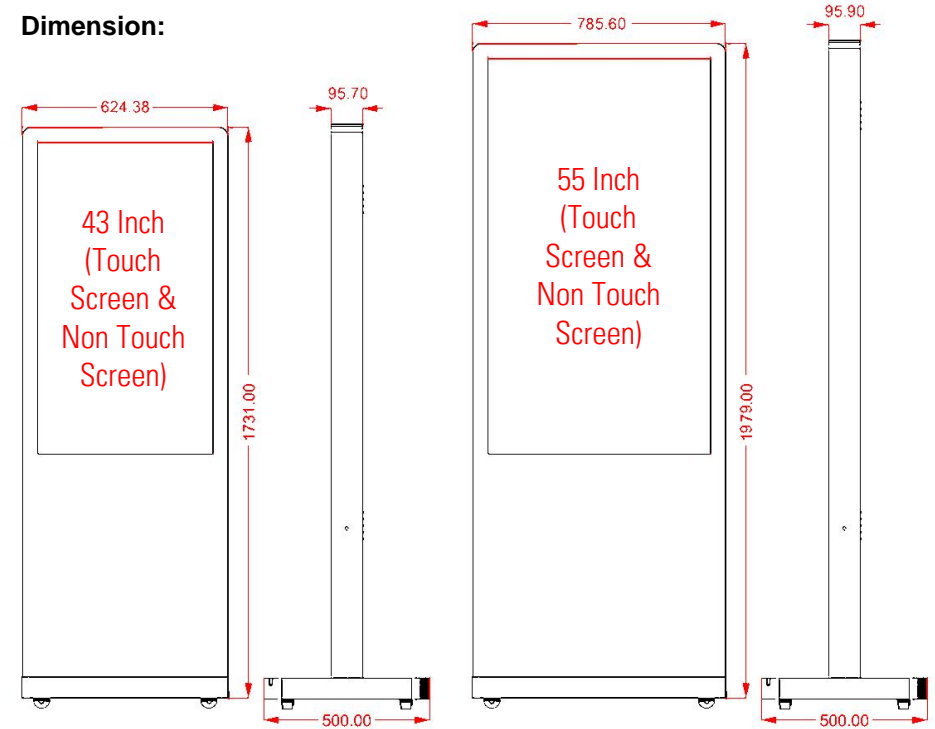

DigiSIGN Floorstand S series Designed for centralized public spaces remote content updates via the Internet, including Cloud CMS. Touch screens provide more interaction for visitors to find products/services offered in the content.

- Available Size 43 and 55 Inch in interactive touch and non touch
- Full Metal Body Fabrication
- Tempered Glass for non touch
- Commercial Grade with 24/7 use
- Update content with DigiSign Play
- Color black (Other Color or size on request)

Specification:

- 10 point IR Touch Overlay for Interactive
- 350-500 Nits Brightness
- Resolution 3840 x 2160
- Network : WIFI, LAN
- Power 100 - 143 W

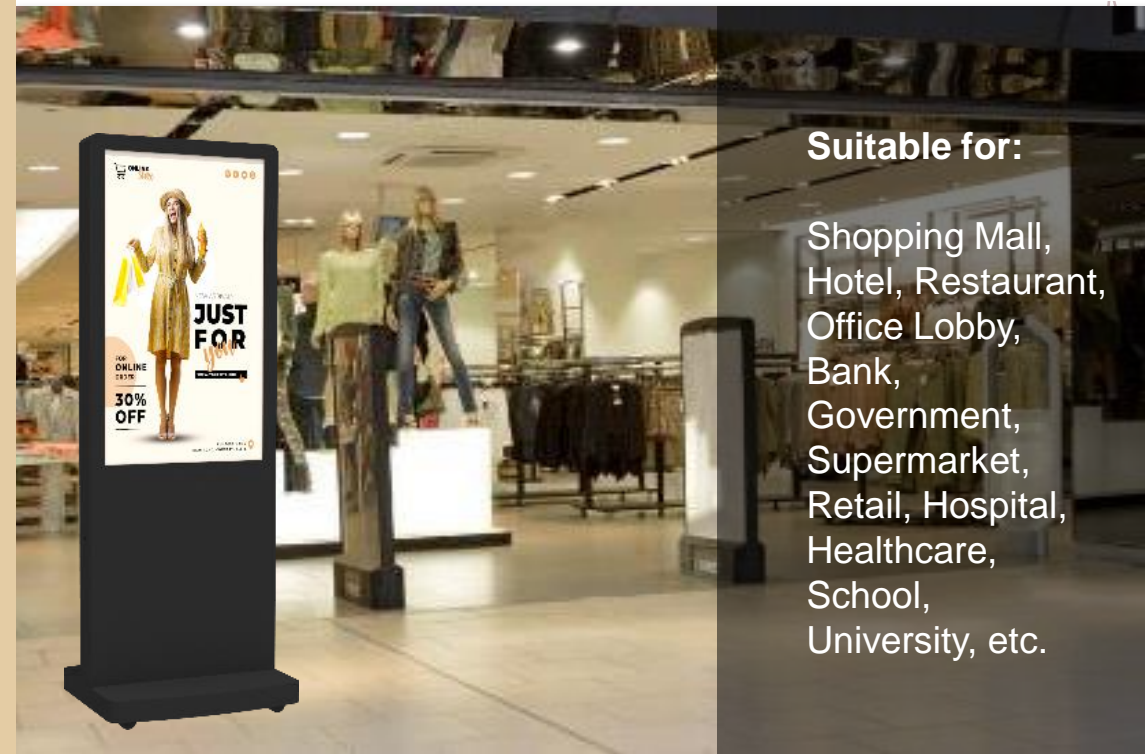

Suitable for:

- Shopping Mall,
- Hotel, Restaurant,
- Office Lobby,
- Bank,
- Government,
- Supermarket,
- Retail, Hospital,
- Healthcare,
- School,
- University, etc.



A series of LCD displays to be placed in various locations with the ease of CMS cloud update, making promotions and information right on target and attracting visitors' attention.

Can be placed in:

- retail shelves between products, window displays
- cashier or teller
- among the line of cosmetic, pharmaceutical products

Consists of various shapes and screen sizes ranging From 8 inches to 21.5 inches, both landscape (Horizontal) and Portrait (Vertical) positions.

Suitable for:

Restaurant, Hotel, Office Lobby, Shopping Mall, Bank, Government Office, Supermarket, Retail, Hospital, Healthcare, etc.



DigiSIGN Desktop 10P Black/White

- 10 inch capacitive touchscreen
- 160x255x114mm / 0.72 kgs



DigiSIGN Desktop 215P + Stand

- 14 inch capacitive touchscreen
- 335x209x25mm / 1.34 kg

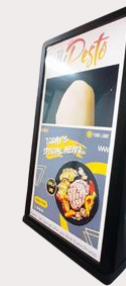

DigiSIGN Desktop 215P + Stand

- 21 inch capacitive touchscreen
- 308x510x35mm / 3,5 kg



Desktop Digital Signage 10L-Double

- 10,1 inch capacitive touchscreen
- 240x132x163mm / 1.29 kg



DigiSIGN Desktop 10L-LB (Black)

- 10 inch capacitive touchscreen
- 250x180x10,9mm / 0,8 kg

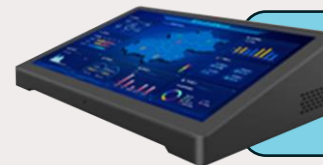

DigiSIGN Desktop Tablet 10L (Black)

- 10 inch capacitive touchscreen
- 258x63x177mm / 0.9kg

General Specification:

Operating system Android 11/Quad core cortex A17
 Brightness 250 nits Brightness
 Storage 2GB RAM, 16 GB Storage
 Connectivity WIFI 802.11 + LAN, USB
 CMS Dignisign Play CMS & Player



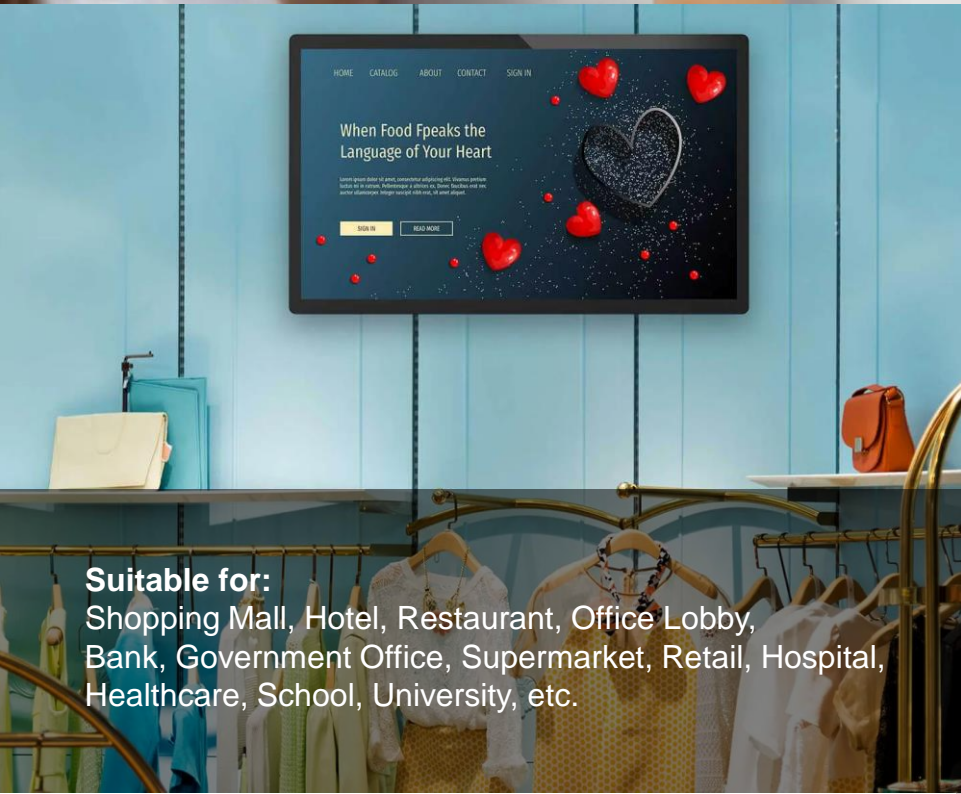
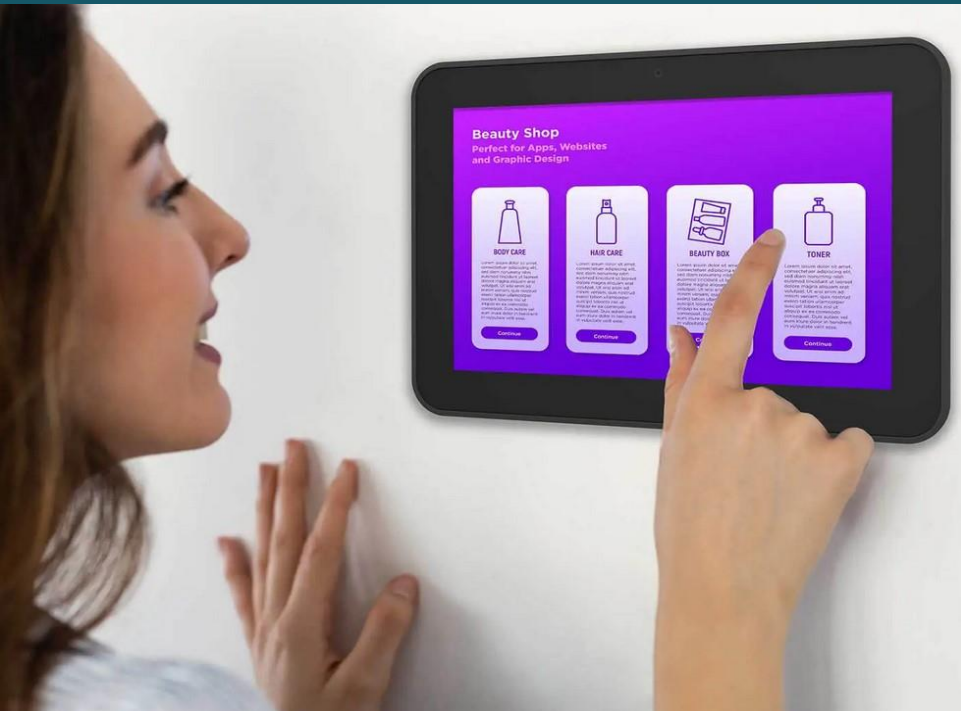

Suitable for:
 Shopping Mall, Hotel, Restaurant, Office Lobby,
 Bank, Government Office, Supermarket, Retail, Hospital,
 Healthcare, School, University, etc.

DigiSIGN Wallmount 10LP (Black)

10 inch 5 points touchscreen

Desktop Stand Available

261(W) x 167.2(H) x 29(D)/0.71 kgs

DigiSIGN Wallmount 14LP (Black)

14 inch Capacitive touchscreen

Desktop Stand Available

335 x 209 x 25 mm / 1.34 kg

DigiSIGN Wallmount 215LP (Black)

22" inch Capacitive touchscreen

Desktop Stand Available

512.8*308.9*33.5mm / 3.76 kg



General Specification

- Operating system android 11/RK3568 - Brightness 250 nits Brightness
- Color Black - Storage 2GB RAM, 16 GB Storage - Resolution 800 x 1280 pixel
- Connectivity WIFI 802.11 + LAN, USB-C - CMS DigiSign Play CMS & Player



Dimension:

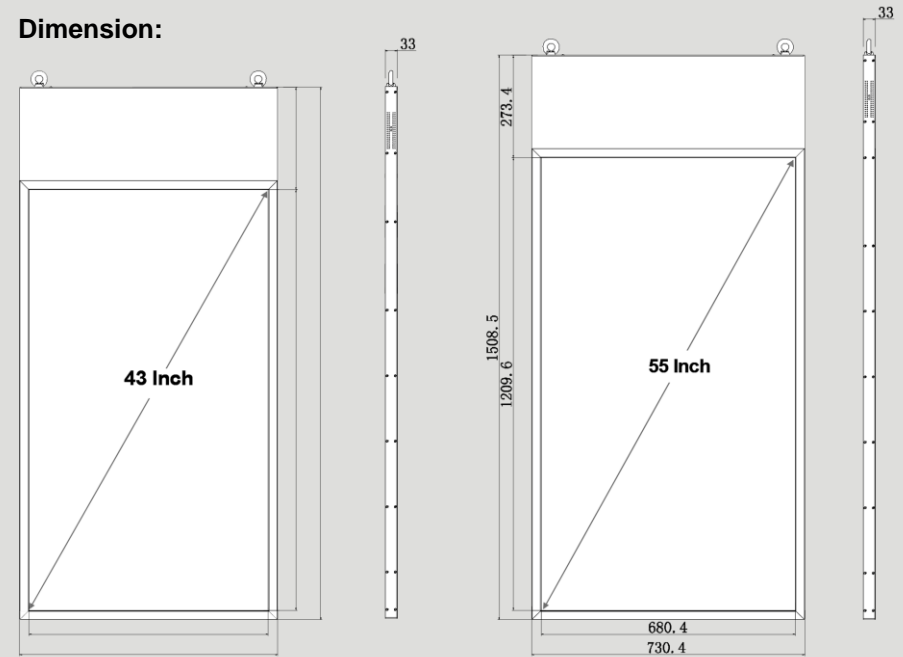

DigiSIGN Dual Side Hanging LCD comes in two sizes, 43 and 55 inch, with a nice sleek white enclosure and incredibly slim profile of less than 35 mm. The screen also comes with an included ceiling mount to easily install in the store.

Key Features:

- Super slim design 33 mm depth
- Unique content for each side
- Higher brightness for window facing side
- Integrated ceiling mount with cable management system

Specification:

- Android 11 RK3568
- RAM 2 GB/16 GB
- 1080 x 1920 Full HD Resolution
- 450cd/m² (for indoor side) and
- 700nits (for indoor window side, can not have direct sunlight)



Suitable for:

Front area of shopping mall, Tenant in shopping mall, Bank, Retail store, Food & Beverage restaurant, Fashion store, etc.



Lift media display with a special design for lifts, With an attractive digital display, audiences can easily see advertisements displayed while in the lift or waiting for the lift.

- Slim & Rounded corner design
- with a strong screen
- Easy Installation
- Content can be easily changed
- Update content with Digisign Play

Available in 22 - 32 inch and 15.6 - 10.1 inch on 2 front screens. With Tempered Glass, WIFI Network.

Suitable for:

Lift Shopping Mall, Lift Hotel, Lift Restaurant, Lift Office, Lift Bank, Lift Government Office, Lift Hospital, Lift School or University, etc.



scan me

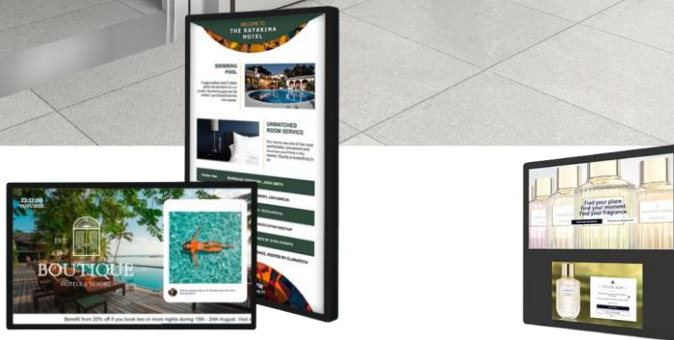

Note How to install a display inside an lift:

- No need to make holes in the lift wall, just use special 3M double-sided VHB tape.
- Electrical connection from inside the lift to the monitor is required

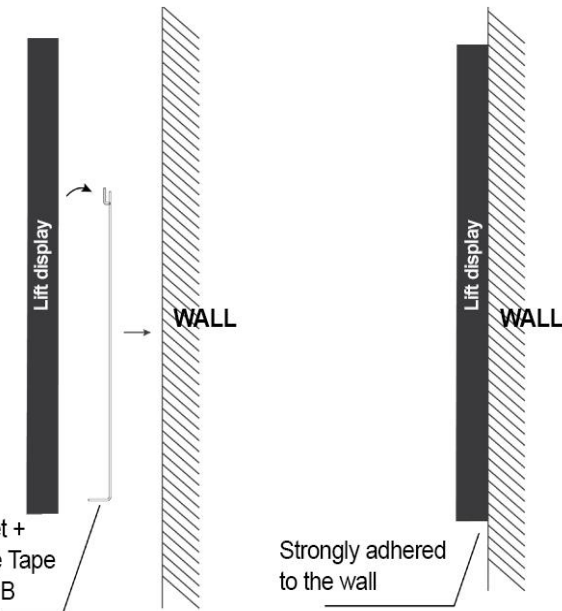

Specification	22 Inch Portrait or Landscape	32 Inch Portrait or Landscape	15.6 Inch + 10 Inch Dual Screen Landscape
Diagonal Size	22 inch	32 inch	15.6 inch & 10.1 inch
Brightness	300 nits	300 nits	250 nits
Dimension (mm)	501.42 x 297 x 33	742 x 439 x 40.6	380 x 394.5 x 27.2
Net Weight	4.8 kg	9.2 kg	2.2 kg



Professional displays used to shown promotional content & simplify business processes, as well as communicate marketing messages, information or promotions to customers.

Key Features

- Industrial / Commercial
- 350 – 700 Nits
- System on Chip, with Digital Signage Features
- UHD / HD-4K
- Auto Power On-off, Timer Scheduling

Specification:

- Brightness Indoor: 350/450/500/700 nits.
- Brightness Outdoor/semi outdoor with 1000/1500/2500 Nits
- Bezel: 6.9(Top)/6.9(Side)/8.9(Bottom) mm
- High durability for long hour usage 24/7
- Typical Size 22, 32, 43, 49/50, 55, 65, 75, 86 and 98 Inch
- Has a digital signage processor
 - Samsung – Tyzen, LG-Web OS, Android.
- Usage suggestions : 12/16/24 Hour/Day.
- Brand : Samsung, LG, TCL



Menu Board System



Portrait usage



Landscape usage

Suitable for:

Retail Store, Factory, Hotel, Hospital, Food resto. Shopping Mall, Office Lobby, Financial Service, Government Office etc.

***Support by Digisign Play for all brand**



Add Digisign Play CMS for managing the content easily

Android TV with Digisign Play for your product promotion needs, at low and economical costs. but does not eliminate the main function.

Key Features

- Economic / Affordable price (Less <50% Pro price)
- Design for home / Low usage 6-12 hours
- Enhance to DS feature by Digisign Android Box

Specification:

- Typical Size 32, Up to 98 Inch
- Brightness Indoor: 350 - 300 nits.
- Bezel varies
- Many brand choices
(Example: Sharp, Aquos, Xiaomi, etc.)

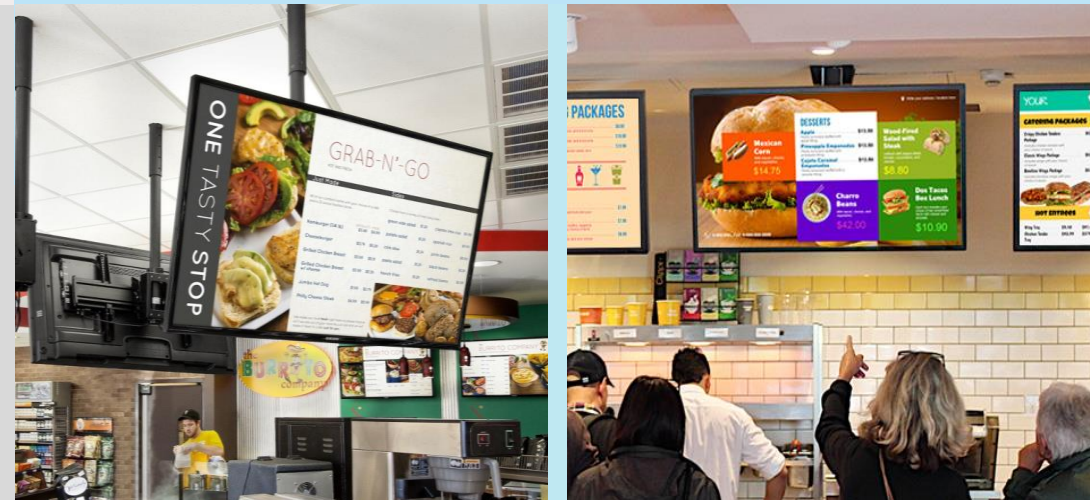

Suitable for:

Factory, Hotel, Hospital, Coffee shop.
Retail Store, Shopping Mall, Restaurant, Office Lobby,
Financial Service, Government Office etc.

***Support by Digisign Play for all brand**



Turn any Digital screen (with HDMI IN input) into a Digital Signage Display with add a DigiSIGN Android Box



Features

- Operating system: Android 11
- CPU: RK3566, Quad-core. GPU: Mali-G52
- RAM: 4GB
- Internal memory: 32 GB
- Connection Support RJ45 100M Ethernet port and Ethernet.
- Power adaptor DC12V 1.5A
- Video Support H.265, VP8, MAV, WMV, AVS, H.263, MPEG4 and other video formats 1080P multi-video decoding
- Image support various picture formats such as JPG, BMP, PNG



DigiSign Play CMS implementation on digital display

Feature	TV HDMI with USB	TV Android / Android box low cost	Digital Screen with DigiSIGN Android box	Professional Display Digital Signage
Timer ON/Off	X	X	✓	✓
Screen Rotation	X	X	✓	✓
Content transition	X	✓	✓	✓
Auto start apps	X	✓	✓	✓
Remote desktop	X	✓	✓	✓
Device monitoring	X	✓	✓	✓



Infosigns or digital menu are designed to help attract customers and make it easier for customers to get information, potentially leading to increased sales.

- 21,5 Inch capacitive touch
- Attractive design & modern
- Easily update your menu in real-time
- Iron frame finished with powder coating

Specification:

- Android 11 RK3568
- 250 Nits Brightness
- Network : WIFI, LAN
- Speaker: 5W*2
- 10-Point capacitive touch
- Resolution 1920x1080
- Power Consumption 25W
- Ram/Memory : 2/16GB

Suitable for:

Restaurant, Office Lobby, Bank, Government Office, Supermarket, Retail, Shopping Mall, Hotel, Hospital, Healthcare, School, University.

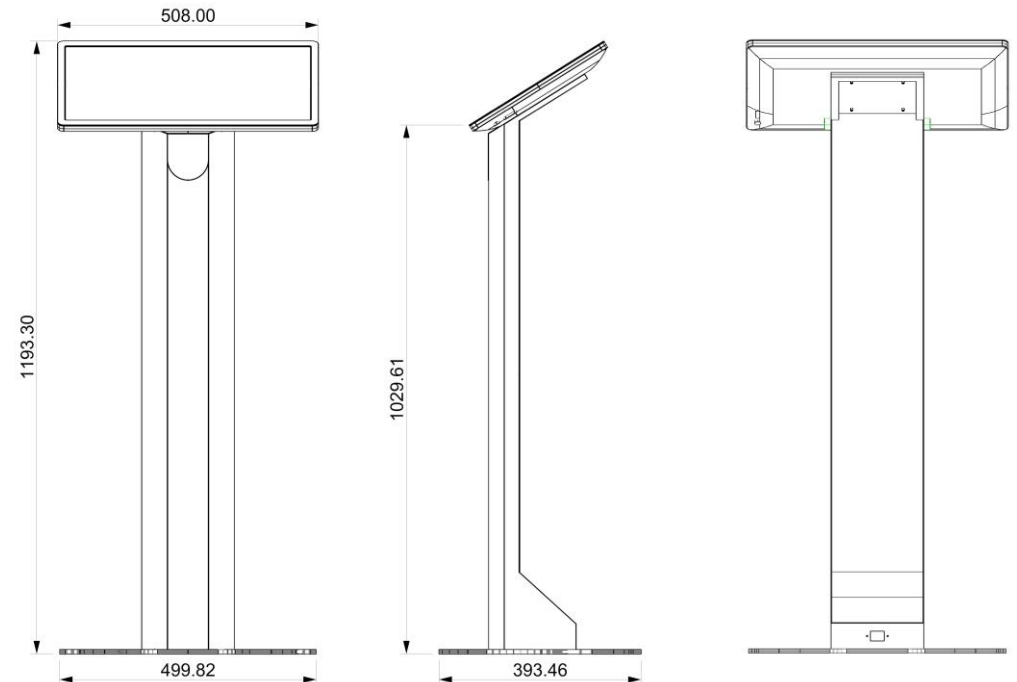



Suitable for:

Home, Gym, Restaurant, Office Lobby, Supermarket, Shopping Mall, Hotel, Hospital, Healthcare, etc.



DigiSIGN Flip Display Smart screen display is a Portable smart device capable of displaying interactive content And easily moved according to your needs

- 24 and 32 Inch touch screen
- Attractive design & modern
- Easily update your content & play.
- Equipped with an internal battery and a sturdy stand
- Camera (Optional)

Specification:

- Android 12
- 250 Nits Brightness
- Network : WIFI, LAN Bluetooth
- Ram/Memory : 8GB/128GB
- 10-Point capacitive touch
- Resolution 1920x1080
- Speaker: 5W*2
- Battery capacity 5200/7500mAh

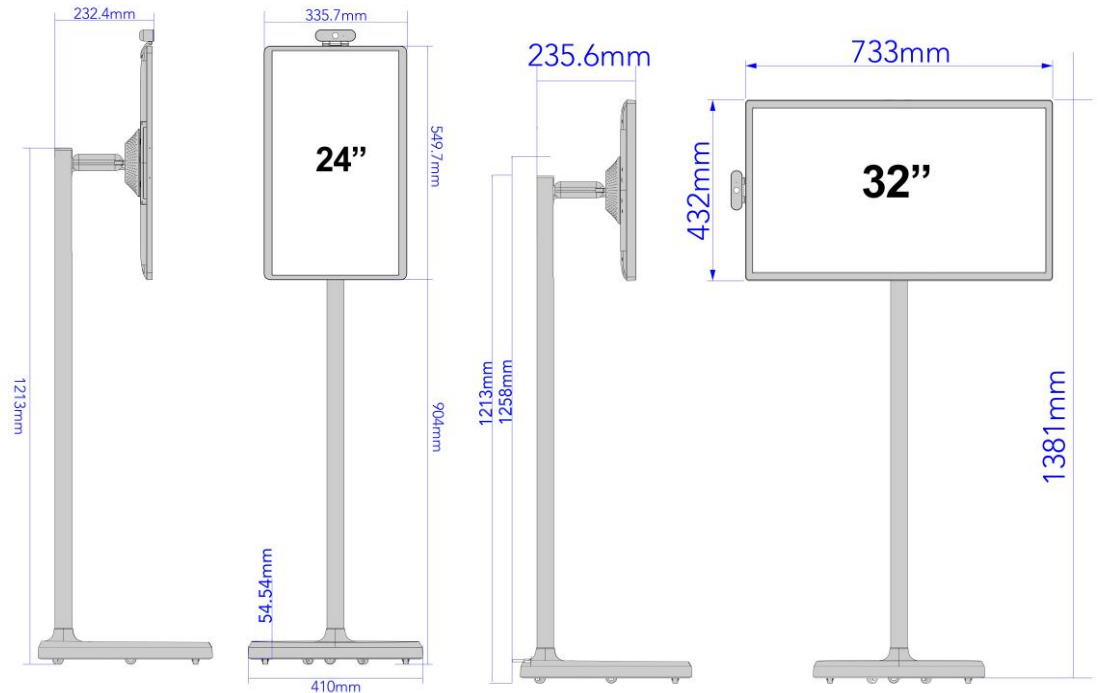



The LED Videotron Options from InnoGRAPH



A Videotron is one of the most effective visual communication tools in this digital era, providing the ability to display engaging and relevant content to a wide audience.

- LED Module with a magnetic system
- Attractive, bright and bright screen display.
- Ease of use, reliable, durable, not easily damaged and faded
- Availability of after sales services and factory support



320 x 360 mm LED Module
Back side covered
P1.8 & P2.5



All in One Module
Module, PCB, Receiving Card,
Power Supply, IC.
In One Body

Selection of 16:9 true ratio from 116 inch up to 318 inch

	32	64	96	128	160	192	224	256	288	320	352	384	416	448	480	512	544	576	608	640	672	704	
36	1	2	3	4	5	6	7	8	9	10	11	12	13	14	15	16	17	18	19	20	21	22	
72	2																						
108	3																						
144	4			256 x 144 cm				116"															
180	5			320 x 180 cm				145"															
216	6			384 x 216 cm				173"															
252	7							448 x 252 cm		202"													
288	8								512 x 288 cm		231"												
324	9										576 x 324 cm		260"										
360	10												608 x 360 cm		289"								
396	11														704 x 396 cm		318"						

Product Parameter:

Model Videotron	Videotron P1,8	Pvideotron P2,5
Pixel Pitch	1,8	2,5
Module Resolutions	171*192	128*144
Module Weight	1,16 kg	
Cabinet Size	320*360*39	
Brightness (cd/m2)	500 nits	600 nits
Power Consumption	295 watt	
Refresh rate (Hz)	3840 hz	
Viewing Angle (H/V °)	117°/H 170°/V	
Maintenance Methods	Front	
Controller	PCON 200 Pro (2K)	





A Videotron in a retail store can attract customers attention by dynamically displaying the latest promotions, special offers, and product information in an engaging way.



Suitable for:

Restaurant, Supermarket, Coffee store, Clothing store, etc

Retail application scenario:

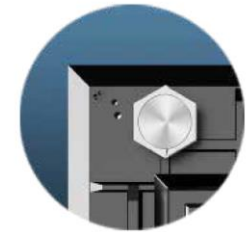

Magnetic Front - Installation

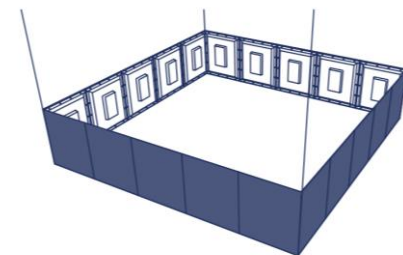

Hanging

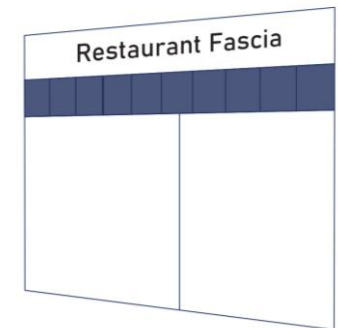

Store Fascia

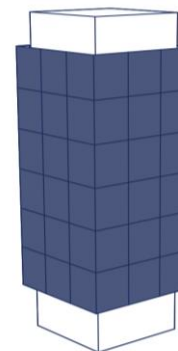

Pillar



Desk

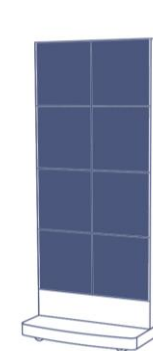

Floorstand

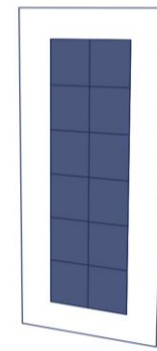

Vertical Banner



scan me



LED Videotron can be used to convey information such as event schedules, announcements, and other important information. Digital screens can be strategically placed to ensure everyone can see them

- Attractive, bright and bright screen display.
- Ease of use, reliable, durable, not easily damaged and faded
- Availability of after sales services and factory support
- Frame construction using hollow galvanized steel



4K Integrated Bar
4K Controller + Soundbar Speaker

Configuration :

Wall Mounted **116 inch up to 318 inch**



With Stand **116 & 145 inch**





A Videotron in a place of worship can be used to display announcements, event schedules, song lyrics, and sermons clearly and engagingly for the congregation.



Installation simulation:



Cinema



University



Office

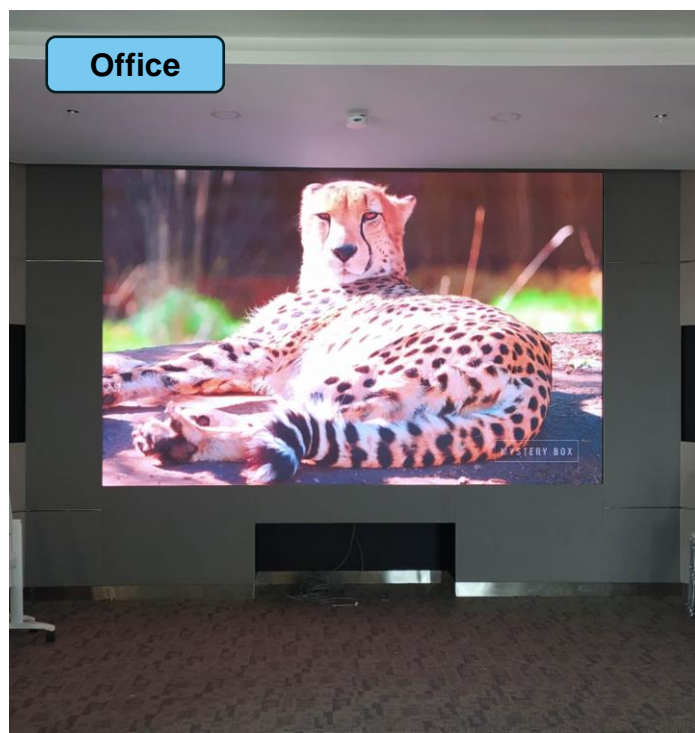

Bank

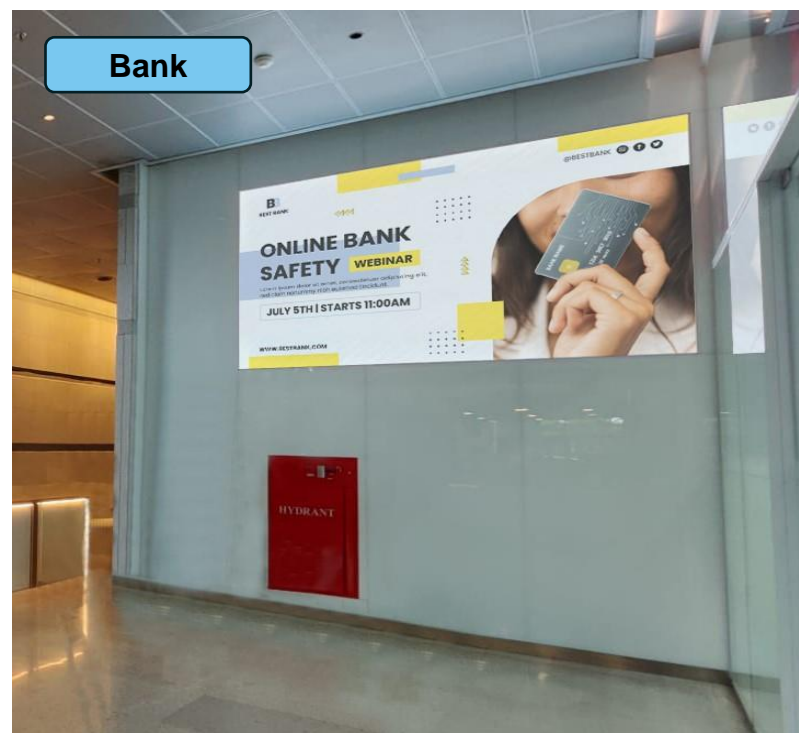

Office Lobby



Die-cast Aluminium Cabinet



Features

- Has international module market standards
- Cost-effective outdoor Videotron.
- Fulfill customer demand for cabinets.
- Avoid installing complicated steel structures.

Specification:

- Pixel Pitch (mm)
2.5 | 3.076 | 4 | 5 | 5.926 | 8 | 10
- Brightness (nit)
5000 | 5000 | 5000 | 5000 | 5000 | 4500 | 5500 | 6000 | 7000
- High contrast of 3000:1
Vivid color, delightful visual experience
- High Refresh rate 3840HZ.
- Size : 960 x 960 x 120mm
- Module Size: 320 x 160mm / 192 x 192mm

Metal Plate Iron Cabinet



Suitable for:

Advertising billboards,
Tower board for Bank,
Government Office,
Shopping Mall, Hotel,
Hospital, University.

LED display special shape develop your creative ideas with this product, you can make various shapes so that your product attracts attention

Basic shape:

- Square 32 x 36 cm
- 45° corner
- Pixel Pitch: P1,8 and P2,5

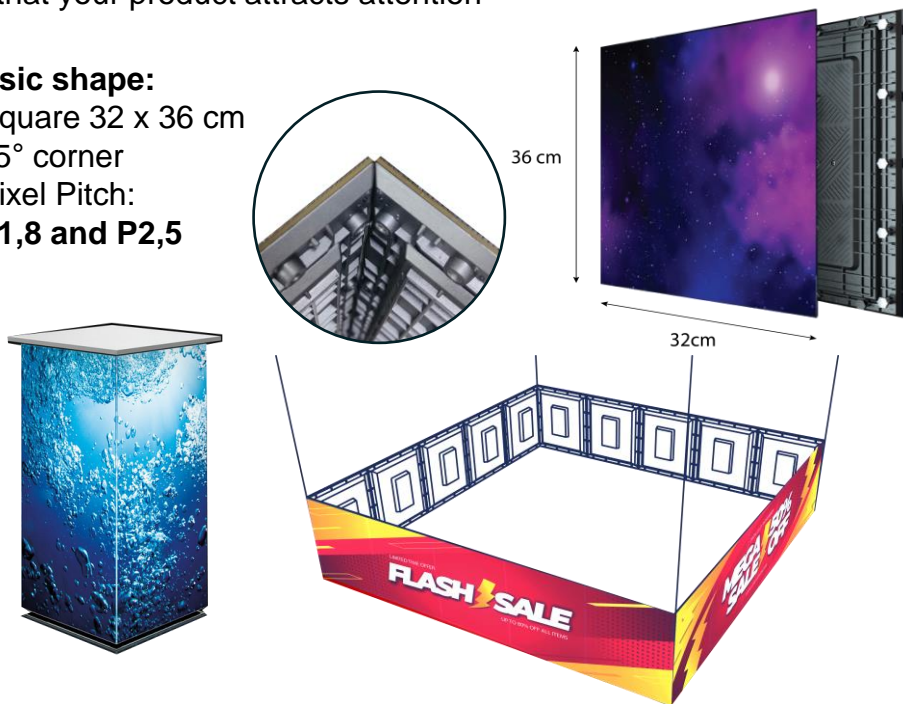

Basic shape:

- Flexible 16 x 32 cm
- Pixel Pitch: P1,5 and P2,6



Case Usage:

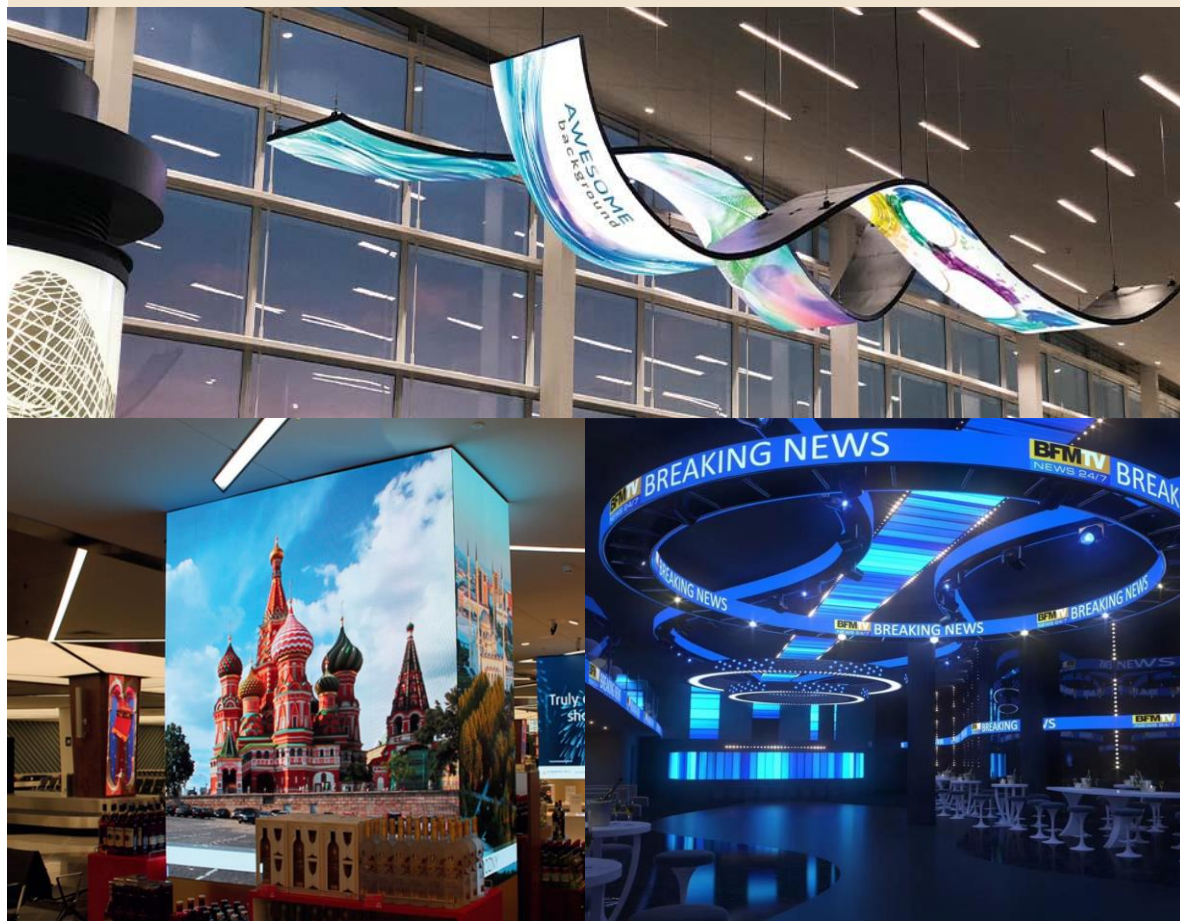

Suitable for:

Shopping Mall, Hotel, Restaurant, Office Lobby, Bank, Government Office, Supermarket, Retail, Hospital, Healthcare, School, University, etc.

Common Specification:

- LED need special bracket / mounting frame
- Digisign Play ready

Custom shape CAN

Pixel Pitch: P2,5



Dimension:



Custom shape CUBE

Pixel Pitch: P2,5 / P3 / P4

Dimension:

- 960 x 960 x 960mm
- 640 x 640 x 640mm



Custom shape SPHERE

Pixel Pitch: P2 & P5

Diameter :

1 M, 1,5 M, 2 M

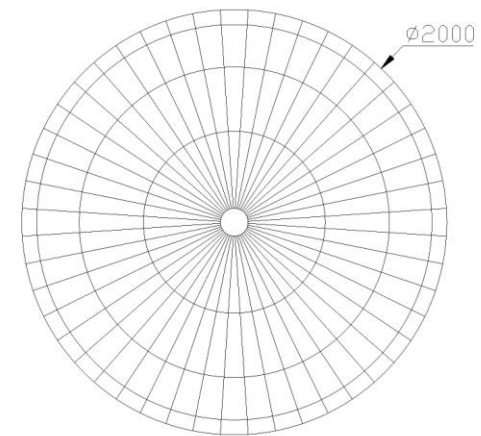
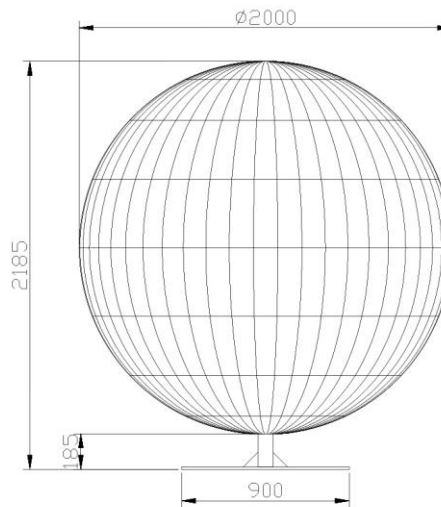

LED cabinet module for rack header

COB P1,5 & P1,8/1,9

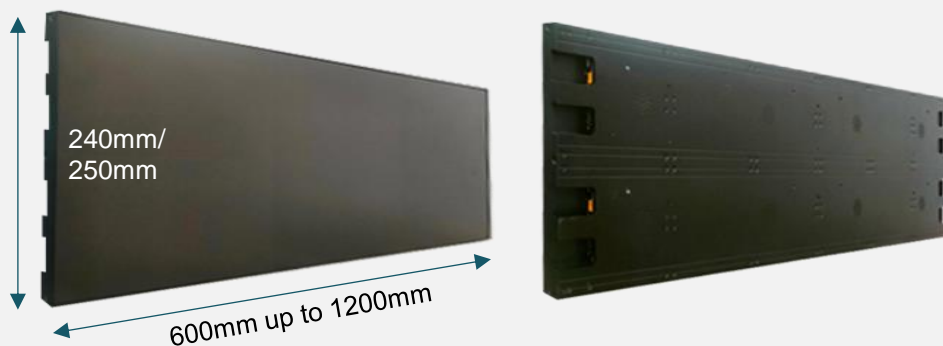

- Basic Size : 600*240mm / 900*240mm /1200*240mm.
750*250mm / 1000*250mm.
- Can be configured according to your needs
- Cabinet finished ready to install.



- Pixel Pitch 1.56
- Brightness 600 nits
- Panel Resolution 384 x 216 dots
- Panel Size (mm): W 600 x H 337.5 x D 39.75
- Maintenance: Full front
- Material: Die-cast Aluminum
- Can be configured according to your needs
- Cabinet finished ready to install.

Case Usage:



Suitable for:

Transportation, Shopping Mall, Restaurant, Supermarket, Retail.

Common Specification:

- Digisign play CMS controlled
- Size configuration can be customized



37 Inch Stretch Display are the ideal and versatile display solution to meet virtually any need.

- Stretched resolution
- 24/7 operation
- 700nit high brightness
- Power consumption: 70W
- 4K UHD viewing experience
- Slim depth design
- OS Tizen 4.0

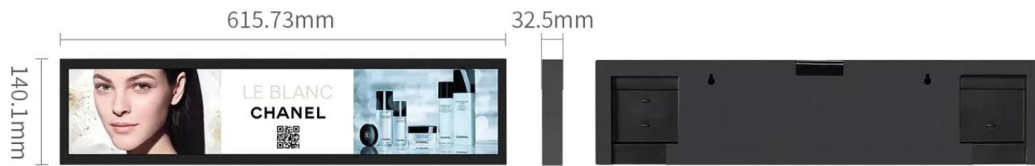

Various other sizes available: **21.2"**, **24"**
28" (735,1 x 168,1 x 33mm) and **37"** (902,11 x 284,4 x 39mm),

General specifications:

- 1920*360 resolution
- OS Android
- Ram/memory 2/16GB
- Network: WIFI, Ethernet, Bluetooth 4,0



Case Usage:

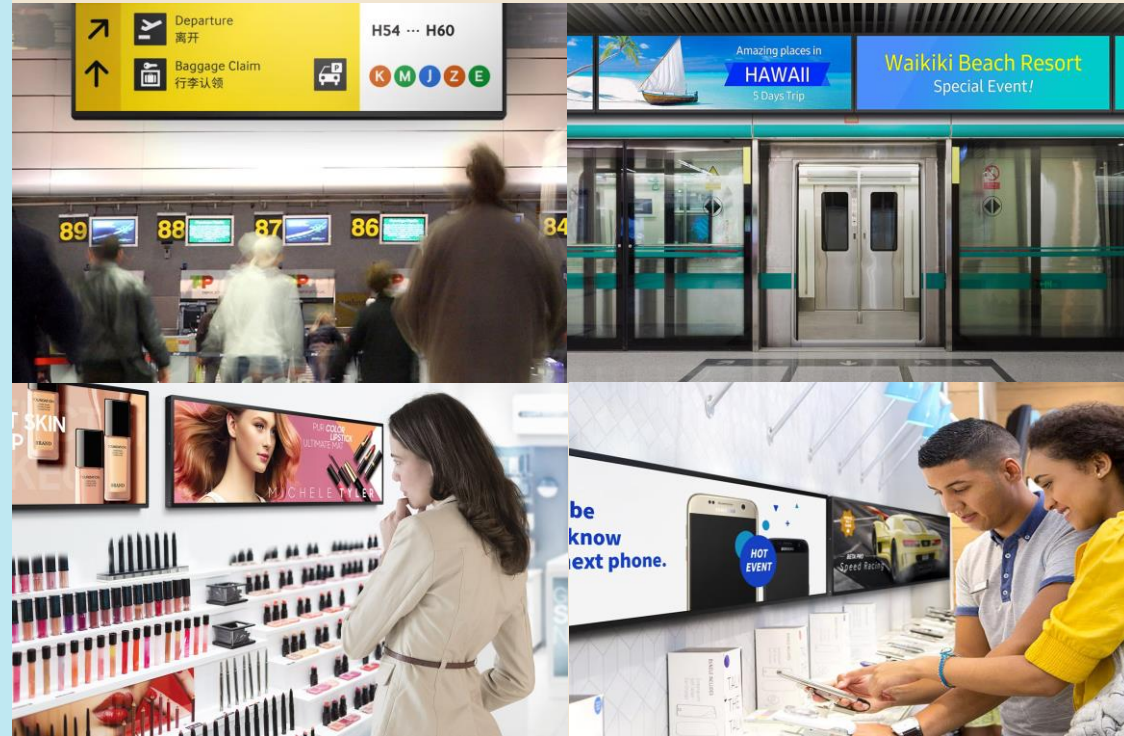

Suitable for:

Public area, Station, Terminal, Shopping Mall, Hotel, Restaurant, Office Lobby, Government Office, Bank, Supermarket, Retail, Hospital, Healthcare, School, University, etc.



LED Transparent is a product that is stunning and has a tremendous influence on product information and promotions with extraordinary display effects

- Flexible, Easy installation, no need steel structure.
- Ultra thin design
- Arbitrary folding and banding
- Seamless splicing

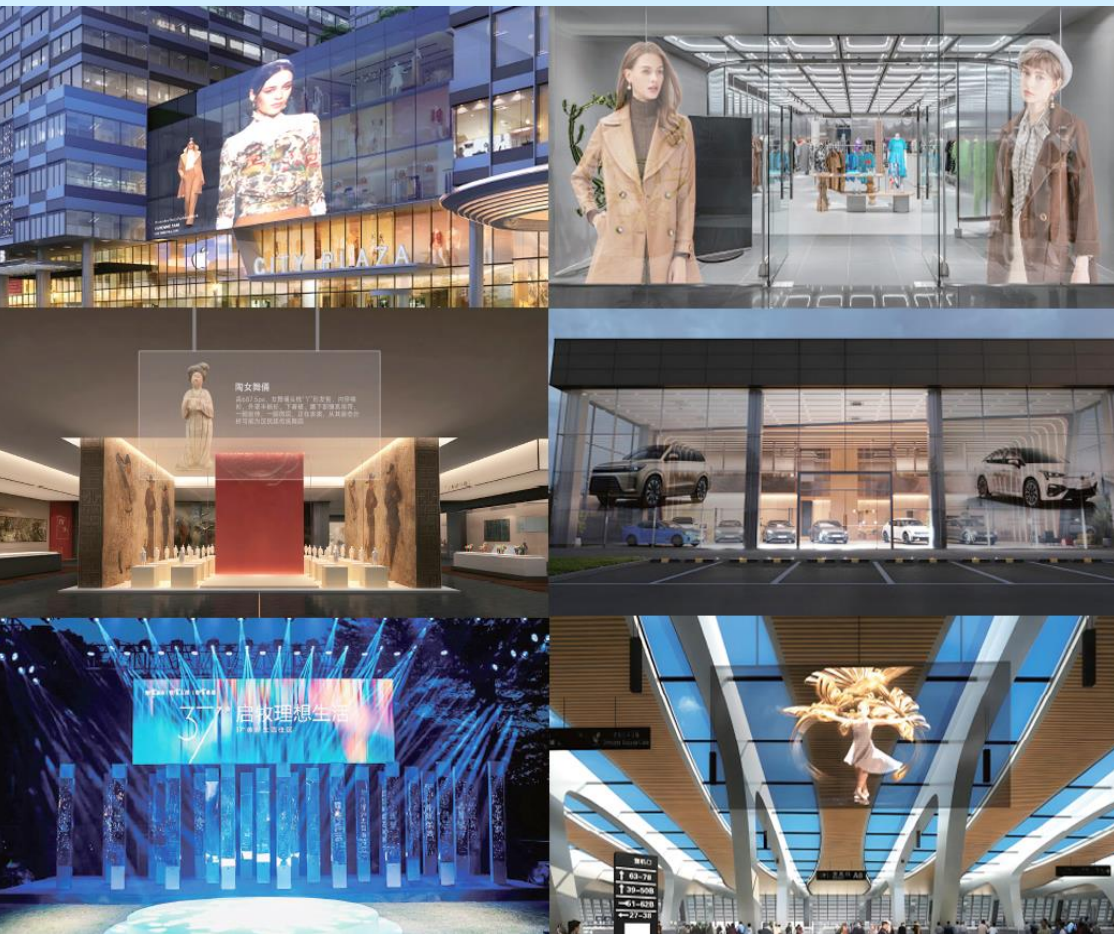

Suitable for:

Public area, Station, Terminal, Shopping Mall, Hotel, Restaurant, Office Lobby, Government Office, Bank, Supermarket, Retail, Hospital, Healthcare, School, University, etc.

1. LED CURTAIN DISPLAY

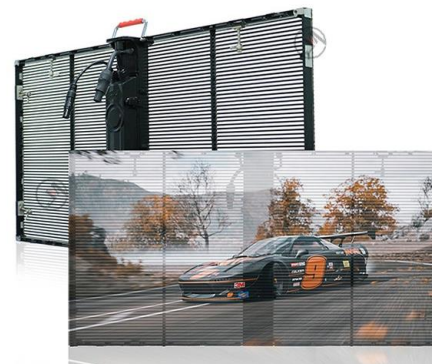

- Model T2,6 : P2.6 - 5.2
- Model T2.8 : P2,84 - 5,62
- Model T3.9 : P3,91 - 7,82
- Model T10 : P10,42
- Model T15 : P15.63

2. LED CRYSTAL FILM SCREEN



- Size Mode 40 x 100 cm
P8, P10, P15, P20
- Size Mode 24 x 100 cm
P4, P4.8, P6, P8, P10

3. LED HOLOGRAPHIC FILM SCREEN

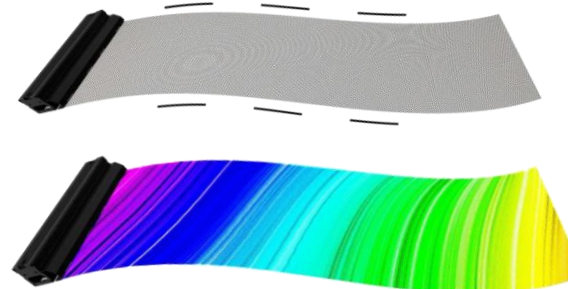

- Size mode 24 x 100 cm
P2.5, P3.91, P6.25

QSTech LED Videotron special size

Ratio 21:9

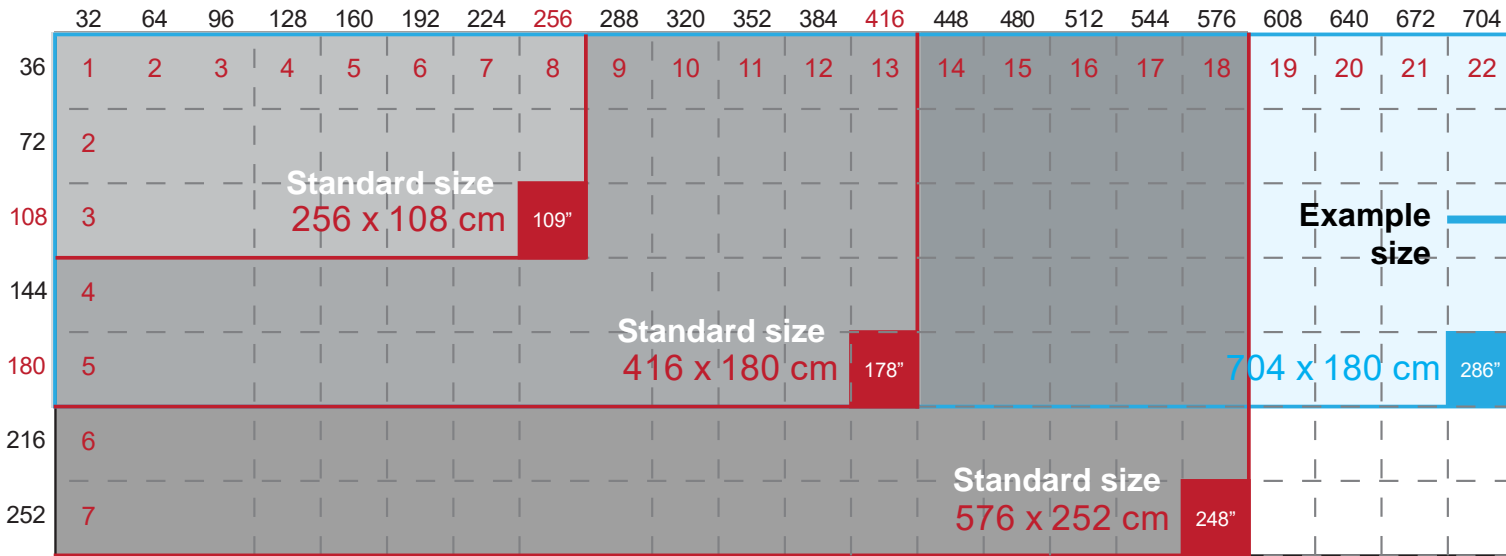

Standard size 21:9:

- 109 Inch (256 x 108 cm)
- 178 Inch (416 x 180 cm)
- 248 Inch (576 x 252 cm)



Example of proportion

- 248 Inch (576 x 252 cm)

LCD special shape ICEBoard

Size 92 Inch Ratio 21:9



General feature:

- Immense ultra-realistic display
- More flexible and more immersive
- IR Touch Display with Zero bonding
- Ultra-wide format
- 5K Resolution (5120x2160)
- Brightness 450 nits
- 7*16 Hours
- RK3588 Android 13 (8G+64G)
- Color Temp sensor/Light sensor
- 80Pin OPS Slot
- 2.1 Channel Audio (2*20W+20W)
- 8*Mic
- WIFI Slot-Optional SI07B supports WIFI 6E
- Versatile Compatibility (Multi-functional USB Type-C)

Case study :





Other Digital Product Solutions from InnoGRAPH



Digital teaching station is a All-in-1 Platform digital classroom With integrated tools and software teaching tools

- Interactive sketcher (Touchscreen).
- Mini PC / NUC Intel WINDOWS Processor.
- Audio out to the speakers in the existing room.
- Ports for *HDMI OUT* to a projector screen / TV / LED Display VIDEOWALL atau Video Tron.
- Supporting Ports for USB data, USB remote pointer.
- Software *Note Whiteboard, Capture (Record) and E-share.*

Specification:

- Metal body Finishing powder coating
- 16 Inch display 10-point touch
- Intel N5105, Windows 10
- Visualizer document and Mic (optional)



Suitable for:
Classroom, School, University.



Suitable for:
 Press Conference,
 Hall room, Houses of worship,
 Lecture, Classroom.

Digital Podium is an All-in-One device specifically designed to make presentations, teaching, lectures and orations interactive.

- Interactive sketcher (Touchscreen).
- Mini PC / NUC Intel WINDOWS Processor.
- Audio out to the speakers in the existing room.
- Ports for *HDMI OUT* to a projector screen / TV / LED Display VIDEOWALL atau Video Tron.
- Supporting Ports for USB data, USB remote pointer.
- Software *Note Whiteboard, Capture (Record) and E-share.*

Specification:

- Metal body Finishing powder coating
- 10-point display 10-point touch
- Visualizer document and Mic
- Windows 10, Available in Intel i3, i5, i7

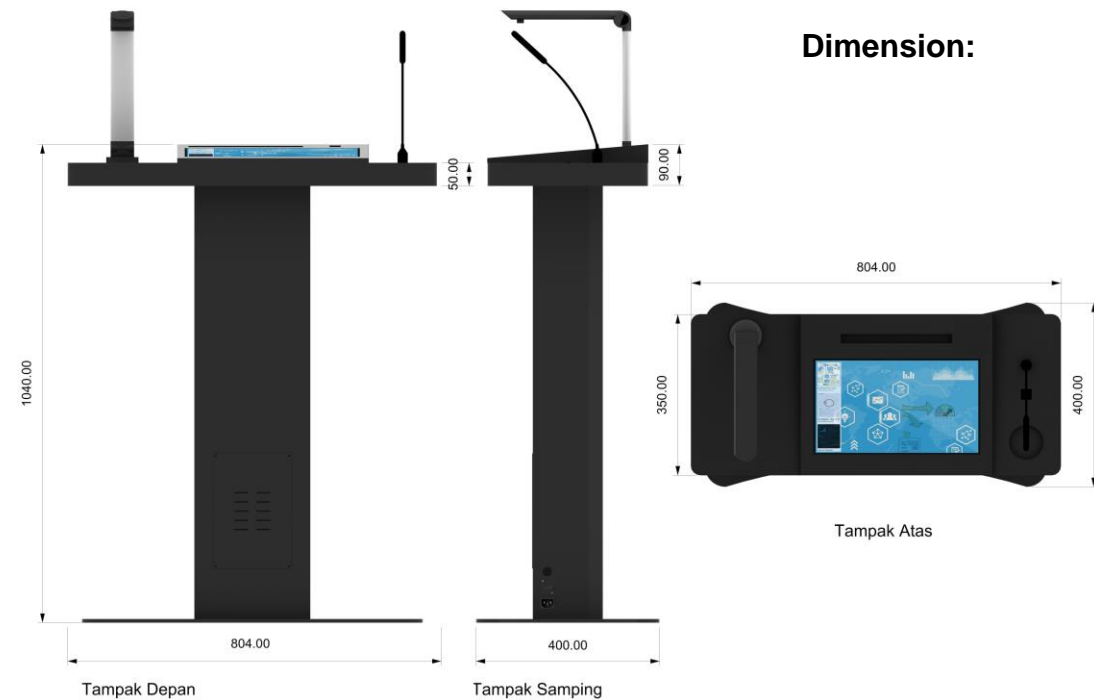

Dimension:



Dimension:

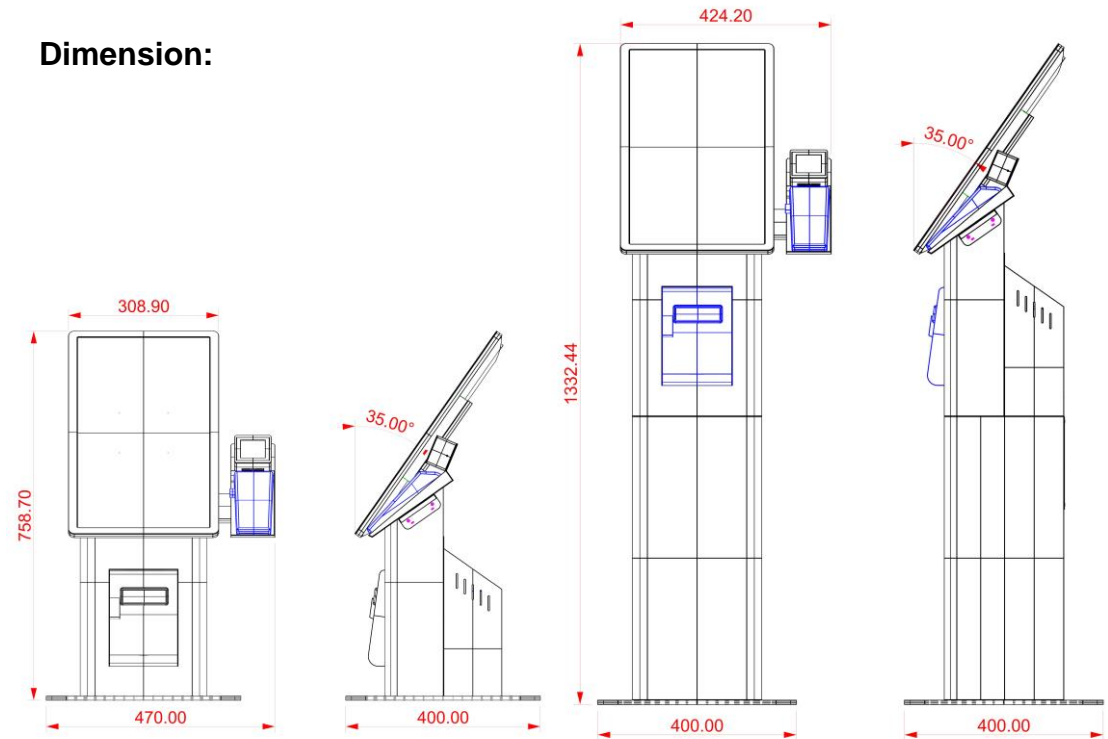

Desktop Type

Stand Type.

DigiSIGN Retail Kiosk is an intelligent device that we created to connect every part of the business, your operations and transactions.

- Two models available: Desk Type & Standee Type.
- 21,5 Inch capacitive touch, QR code. Thermal printer.
- Attractive design & modern
- Iron frame finished with powder coating

Specification:

- Android 11 RK3568
- 250 Nits Brightness
- Network : WIFI, LAN
- Speaker: 5W*2
- 10-Point capacitive touch
- Resolution 1920x1080
- Power Consumption 25W
- Ram/Memory : 2/16GB

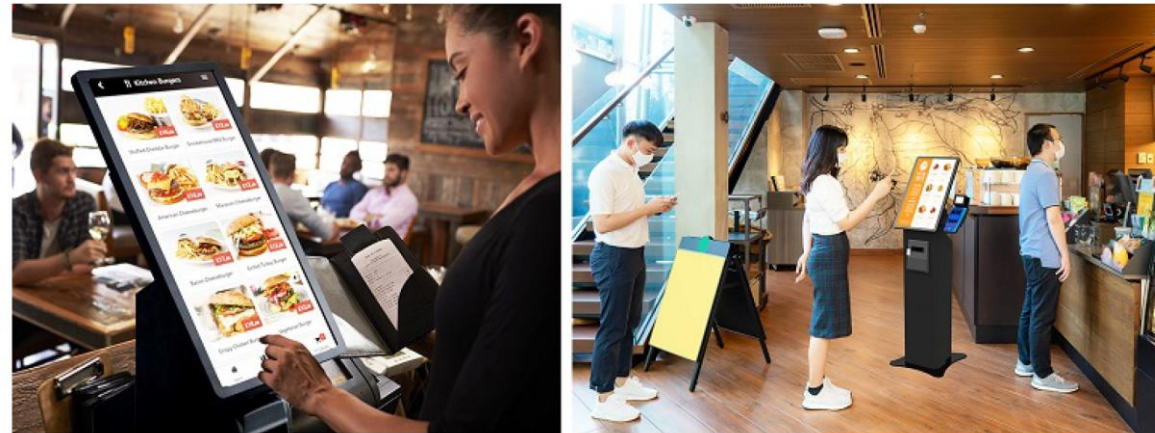

Suitable for:

Coffee Shop, Quick Service Restaurant, Café, Food & Beverage Business, etc.



scan me



A device that combines the functionality of a table or stand with an interactive touchscreen display. These devices are designed to provide users with an engaging and user-friendly interface for accessing information, services, or content.

Player Options:

1. Advanced Interactive Control Box : Android 11
4 GB Memory / 32 GB Storage
2. Mini PC : Windows 10 IoT – Intel i5
8 GB Memory / 512 GB SSD Storage



Software:

- Digisign Play software (Cloud-based Subscription CMS) – Android/Windows
- Omnitapps – Windows



Specifications:

Variant	S Series	V Series
Size	43, 50, 55 inch	32, 43, 49, 55 inch
Brightness	500 nits	400 nits
Resolution	4K UHD	Full HD
Color	Black / White	Black Only
Touch Type	10 points IR Touchscreen	10 points IR Touchscreen

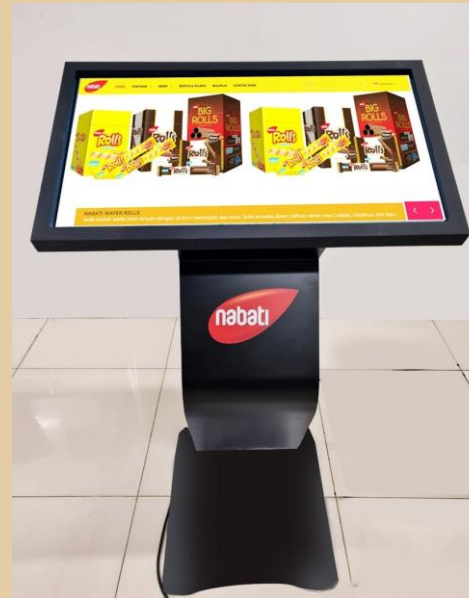

Suitable for:

- Interactive Signage
- Information Kiosks
- Educational Tools
- Menu Kiosks
- Directories or wayfinding information
- Lobby, Airport, Station, Museum, Retail, Shopping Mall, Hotel, Restaurants, Exhibition, etc.



Our **ICEBOARD X2 Series** redefines meeting experiences. Designed to elevate meetings, our comprehensive solution empowers every participant to unleash their creativity and captivate audience

- Available in 86 inches
- Resolution 4K (UHD) for all sizes (75 & 86 inches) including built-in 8 array microphone, speaker and 50MP automatic focus camera.
- Android 14 with 8GB RAM, 128GB ROM
- Bytello Ecosystem includes Bytello Share, Bytello OS, Bytello DMS, Bytello Class, and Bytello Class Pro.
- Account Management with Google Account / Microsoft Account integration using Bytello OS. Remote / Control Device IFP using Bytello DMS.
- Content sharing using Bytello Share up to 9 devices and broadcast feature to all devices on the same network.
- Copy Display to other IFP ICE Boards maximum 6 devices.
- Picture in Picture, Note Whiteboard, Share files via QR Code, Gmail / MS Account collaboration.

ULTRA HD
4K



40 POINTS
TOUCH



ANTI GLARE



Android system

OPS Mini PC

Operation system	Android 14	Windows 11 IoT Enterprise
CPU	A72×4 + A53×4	Intel i5
RAM	8 GB	8 GB
ROM / SSD	256 GB	256 GB
Software Apps	Bytello OS, Bytello Share, Bytello DMS, Bytello Class	Windows



Suitable for:
Meeting room, Class room



scan me



**Product Display Solutions
from InnoGRAPH and
Customer Support
Facilities**

Project Reference



Client: PT Pegadaian Indonesia
Product: Digital Floorstand
Project Volume: 232 units
Timeline: 2020
Coverage: Jabodetabek



Client: Mahkamah Agung Indonesia
Product: Vestouch Android Interactive Kiosk
Project Volume: 843 units
Timeline: 2019
Coverage: Nationwide



Client: The Westin Resort Nusa Dua Bali
Product: Samsung Smart Signage 24", 98", DigiSIGN Floorstand 55 S Series
Project Volume: 41 units
Timeline: 2023 - 2024
Coverage: Bali

Project Reference

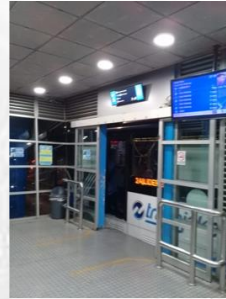

Client: PT Transportasi Jakarta
Product: SAMSUNG Edge-Lit 37" LED Stretched
Project Volume: 251 units
Timeline: 2019 - 2021
Coverage: Jakarta

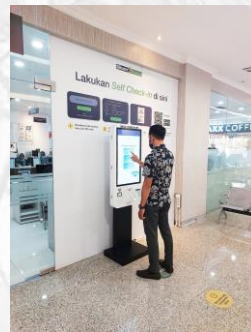

Client: Siloam Hospital
Product: Digisign Self Service Kiosk & Self Order Kiosk
Project Volume: 57 units
Timeline: 2023
Coverage: Nationwide

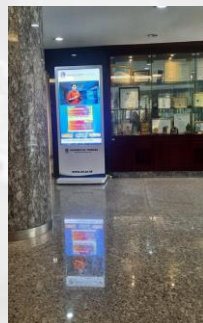

Client: Universitas Terbuka
Product: Digital Floorstand 65 inch
Project Volume: 54 units
Timeline: 2021 - 2022
Coverage: Nationwide

Project Reference



Client: PT China Construction bank Indonesia
Product: Digisign LED Display (Digitron) Indoor P1.8
Project Volume: 1 unit; Size 3,20 x 1,8 m
Timeline: 2023
Coverage: Jakarta



Client: RS Mata JEC-Orbita
Product: LED Display (Lampro) Indoor P2.5
Project Volume: 1 unit; Size: 3,84 x 2,24 m
Timeline: 2023
Coverage: Makassar



Client: PT Siname Agung Mandiri (Flix Cinema)
Product: Digisign LED Display (Digitron) Indoor P1.8
Project Volume: 1 unit; Size 1,92 x 1,08 m
Timeline: 2023
Coverage: Jakarta

Other display solutions from InnoGRAPH



Backwall & Backdrop



Frame Stand



Event Desk



Lightbox



Building Sign

Facilities



Head Office



Meeting Room



Warehouse



Production & QC

Innovative Team



Our Brands



COME AND SEE OUR SHOWROOM



www.innograph.com



www.displaystore.id



PT. Inovasi Sarana Grafindo

Jl. Lenteng Agung Raya No. 15 Jakarta Selatan 12610 Indonesia.

cs@innograph.com WA: [+62 815 1028 2828](tel:+6281510282828)